

Igo 50

product guide

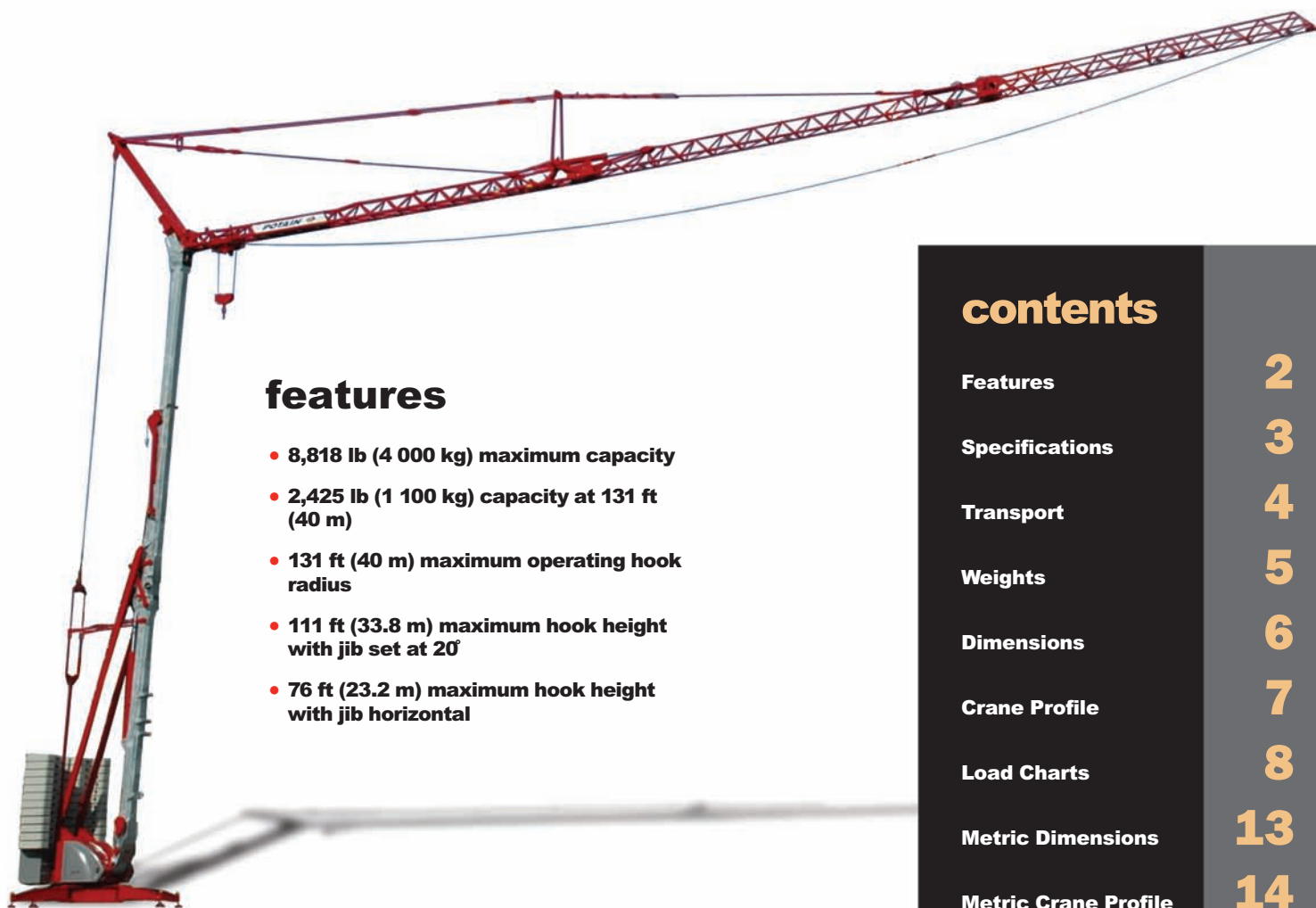

features

- 8,818 lb (4 000 kg) maximum capacity
- 2,425 lb (1 100 kg) capacity at 131 ft (40 m)
- 131 ft (40 m) maximum operating hook radius
- 111 ft (33.8 m) maximum hook height with jib set at 20°
- 76 ft (23.2 m) maximum hook height with jib horizontal

contents

Features	2
Specifications	3
Transport	4
Weights	5
Dimensions	6
Crane Profile	7
Load Charts	8
Metric Dimensions	13
Metric Crane Profile	14
Metric Load Charts	15
Mechanical Data	20
Symbols Glossary	21

features

2



IGO 50s working together to quickly and quietly create new urban transportation system.



Variable frequency drives provide a lower initial current rush and progressive speed change which can be supported by a smaller generator set than comparable cranes; jib folded back for 97 ft (29.6 m) radius operation for improved lifting capacities and obstacle avoidance.



Optional highway transport axle set SL122/J215M can travel at speeds up to 50 MPH (80 KPH) without the use of a trailer.



Flat outrigger pads easily stow on crane during transport.



Optional fixed height cab and access ladder allows operator to view the job site from a more advantageous position.

Igo 50

specifications

3

Jib

118 ft (36 m) radius standard bi-folding offsettable lattice jib. Two (2) tie bar lines with adjustable lengths allow jib to be offset 8° and 20°. Folds to 46 ft (13.9 m) radius or 97 ft (29.6 m) radius. Two (2) erecting speeds controlled from the remote, opening and aligning are carried out automatically by two (2) hydraulic cylinders.

*Optional Jib Extension

13 ft (4 m) removable jib extension allows maximum radius of 131 ft (40 m).

Mast

Galvanized folding mast with hydraulic cylinder for erection. Two (2) erecting speeds controlled from the remote. No locking necessary. 360° rotation possible during erection.

Chassis

Outriggers swing and lock into position. 14 ft 8 in (4.5 m) square outrigger spread with 8 ft 2 in (2.5 m) slewing radius. Level bubble integrated into the chassis. Outrigger pads are stowed on the crane during transport (21" x 16" [540 x 410 mm]). *Optional outrigger pads available at heights of 7.9 in (200 mm) and 15.7 in (400 mm).

Ballast

12,434 lb (5,640 kg) concrete ballast standard. Crane with standard ballast is able to be transported on several *axle sets. *Additional 50,265 lb (22,800 kg) concrete ballast optional.

*Optional Hydraulic Ballasting Derrick

Uses the hoisting winch to ballast the crane or dismantle/attach *fifth-wheel. Stows alongside the jib during transport.

Electrical Requirement

480 volt, 60 Hz measured at the turntable. Earth rod and electric cable stowed on the crane during transport.

Reeving

SM/DM block for 2 or 4-part line. One pin removal to change between SM and DM. Pure SM1 (section of hook block removed) is possible with gain of 220 lb (100 kg) lifting capacity.

Controls

Wireless remote control provides information to the operator about **wind speed, radius, hook height, load, and moment. Lights and buzzers alert the operator when nearing limits of operation.

Auxiliary remote attached by umbilical cord ensures continual operation in case of battery or other malfunction of the wireless remote control.

*Denotes optional equipment

*Optional Anemometer

Electronic wind speed meter to alert the operator of wind speed conditions. Provides selective display on the radio remote. Crane can be erected in wind speeds up to 25 MPH (40 KPH), operated in speeds up to 45 MPH (72 KPH) and weather vaned in winds up to 93 MPH (150 KPH).

Swing

RVF+51 slewing mechanism with maximum swing speed of 0.8 RPM. Progressive control of speed with counter-slewing possible, anti-load swinging system makes aligning the load and jib easier. Multiple RPM speeds possible depending upon parameter selected.

Hoist

15 LVF 10 Optima: 15 HP variable frequency hoist with 1.1 Ust (1 t) line pull. 3 notch, progressive speed change according to the accelerating or decelerating ramps. Optima allows the hoist to adapt its speed to the weight of the load.

Trolley

3 DVF 5: 3 HP variable frequency hoist with 1,102 lb (500 kg) line pull. 2 notch winch, progressive speed change according to acceleration or deceleration ramps controlled by the frequency converter.

Hydraulic Equipment

Four (4) cylinders and two (2) pumps linked to solenoid valves. Two (2) cylinders for unfolding the jib, one (1) for slewing the derrick, and one (1) for raising the mast.

*Optional Transport Axle Sets

Axle sets are available for both jobsite and highway applications. Jobsite axles are rated at either 6 MPH (10 KPH) or 15.5 MPH (25 KPH); highway axle set is rated at 50 MPH (80 KPH).

*Optional Equipment

- * STANDARD NORTH AMERICAN SPECIFICATION: includes 13 ft (4 m) jib extension, hydraulic ballasting derrick, high sole plates, and Dialog Wind.
- * 13 ft (4 m) jib extension to reach maximum radius of 131 ft (40 m)
- * High outrigger pads (19" x 19" [500 x 500 m] – 8" [200 mm] height)
- * Very high outrigger pads (19" x 19" [500 x 500 m] – 16" [400 mm] height)
- * Fixed height cab and access ladder
- * Transport axles and kits
- * Top Zone
- * Top Tracing
- * Dialog Wind

Consult price list for additional options

**Requires optional anemometer

Igo 50

4

DJ100 / S120

6 MPH / 10 KPH

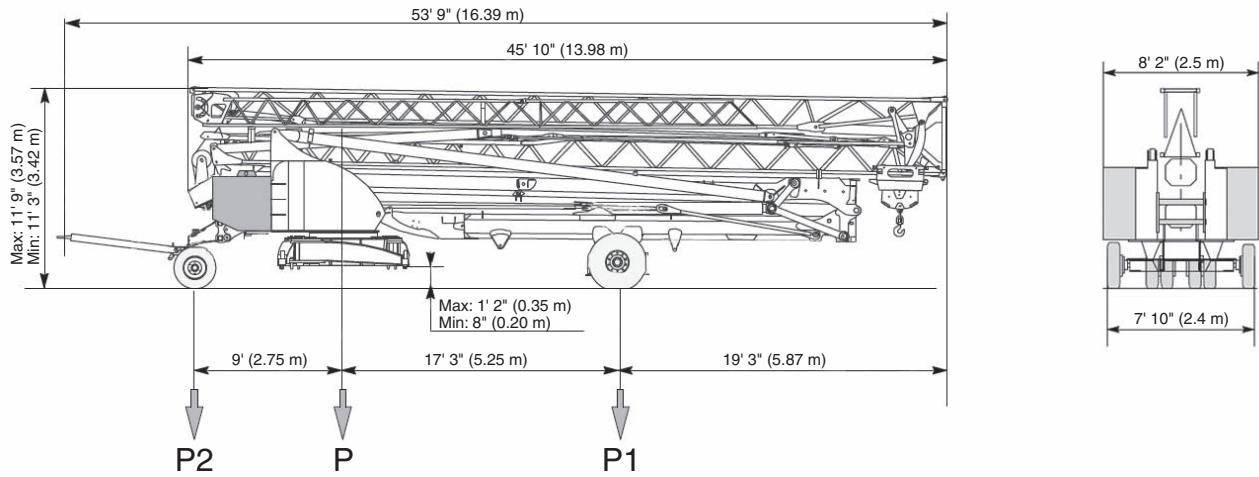

SL121 / J135

15.5 MPH / 25 KPH

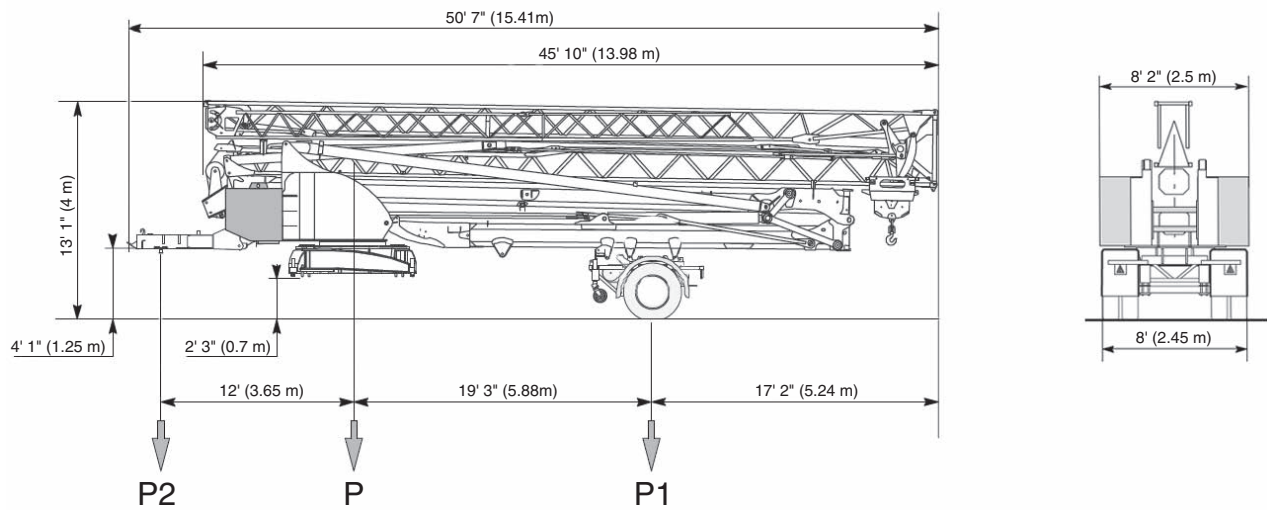

Igo 50

NOTE: Dimensions and weights may vary due to manufacturing tolerances.

SL122 / J215M

50 MPH / 80 KPH

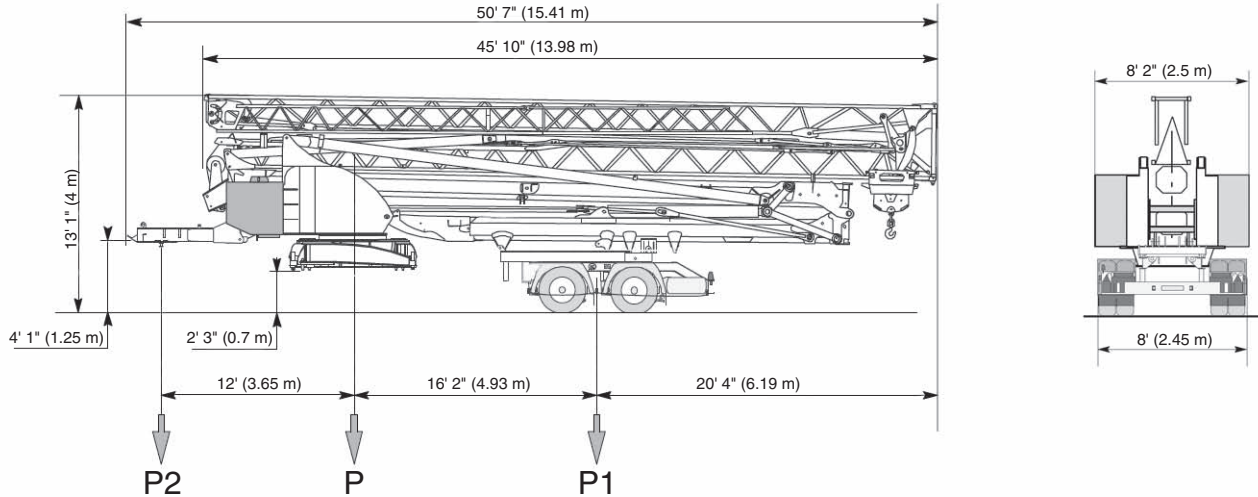

*Other axle sets are available.

Chassis Data (in transport position)

	DJ100/S120		SL121/J135		SL122/J215M	
	15.5 MPH / 25 KPH		15.5 MPH / 25 KPH		50 MPH / 80 KPH	
	(feet)	(meters)	(feet)	(meters)	(feet)	(meters)
Overall Length	53.77	16.39	48.46	14.77	48.46	14.77
Overall Height	Max: 11.71 Min: 11.22	Max: 3.57 Min: 3.42	13.12	4.0	13.12	4.0
Overall Width	8.2	2.5	8.2	2.5	8.2	2.5
Overhang	19.26	5.87	17.19	5.24	20.31	6.19

Weights

Crane Weight less Counterweight:	32,628 lb	14,800 kg
Counterweight for Operation:	62,700 lb	28,440 kg
Crane with Counterweight:	95,328 lb	43,240 kg

Crane with Transport Equipment

	DJ100/S120		SL121/J135		SL122/J215M	
	6 MPH / 10 KPH		15.5 MPH / 25 KPH		50 MPH / 80 KPH	
	(pounds)	(kilograms)	(pounds)	(kilograms)	(pounds)	(kilograms)
In Transport with minimal counterweight:						
Gross (P)	47,741	21,655	49,592	22,495	52,139	23,650
Rear (P1)	25,849	11,725	28,660	13,000	33,951	15,400
Front (P2)	21,892	9,930	20,933	9,495	18,188	8,250
Counterweight in transport (2 blocks):	12,434	5,640	12,434	5,640	12,434	5,640

NOTE: Dimensions and weights may vary due to manufacturing tolerances.

dimensions

6

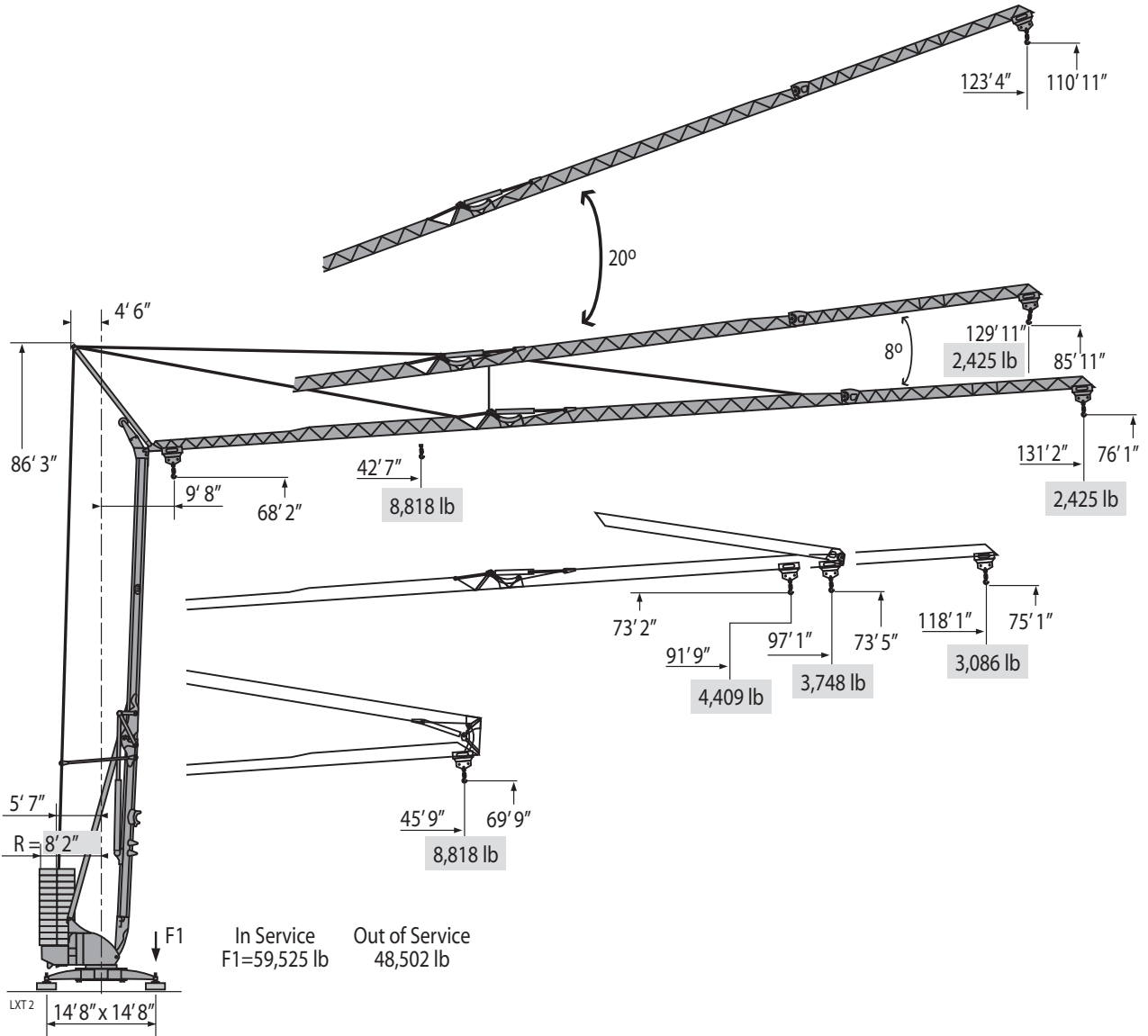

Unit Weight: 32,792 lb.

Igo 50

THIS CHART IS ONLY A GUIDE AND SHOULD NOT BE USED TO OPERATE THE CRANE. The individual crane's load chart, operating instructions and other instructional plates must be read and understood prior to operating the crane.

crane profile

7

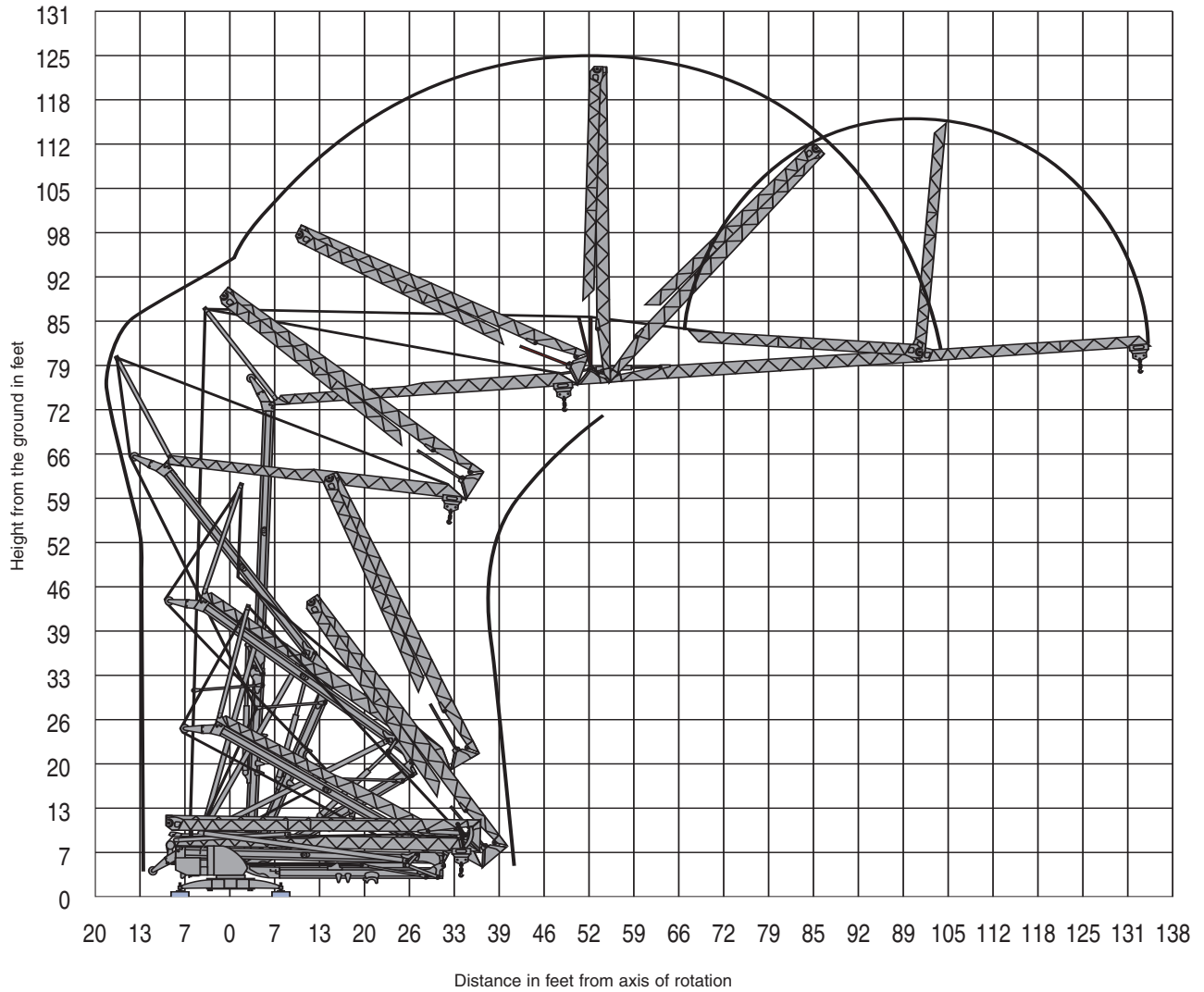

THIS CHART IS ONLY A GUIDE AND SHOULD NOT BE USED TO OPERATE THE CRANE. The individual crane's load chart, operating instructions and other instructional plates must be read and understood prior to operating the crane.

Igo 50

load charts

8



Jib Configuration: L40 with maximum hook reach of 131'-3" at 0°

Hook Reach (ft)	9'-10"	42'-6"	45'-11"	49'-3"	52'-6"	55'-9"	59'-1"	62'-4"	65'-7"	75'-6"	78'-9"	79'-5"	82'-0"	88'-7"	98'-5"	105'-0"	114'-10"	121'-5"	131'-3"
Reeving	Capacities (lbs)																		
SM1	4,409	4,409	4,409	4,409	4,409	4,409	4,409	4,409	4,409	4,409	4,409	4,409	4,233	3,869	3,417	3,164	2,844	2,668	2,425
SM	4,409	4,409	4,409	4,409	4,409	4,409	4,409	4,409	4,409	4,178	4,136	3,968	3,616	3,175	2,932	2,612	2,436	2,205	
DM	8,818	8,818	8,080	7,419	6,845	6,360	5,930	5,556	5,214	4,409	4,178	4,136	3,968	3,616	3,175	2,932	2,612	2,436	2,205

Maximum Hook Heights at Jib Tip: H = 76'-1"
Maximum Hook Heights at Jib Foot: H = 68'-3"



Jib Configuration: L36 with maximum hook reach of 118'-1" at 0°

Hook Reach (ft)	9'-10"	46'-11"	49'-3"	52'-6"	55'-9"	59'-1"	62'-4"	65'-7"	72'-2"	79'-5"	83'-0"	85'-4"	87'-3"	88'-7"	98'-5"	105'-0"	114'-10"	118'-1"	
Reeving	Capacities (lbs)																		
SM1	4,409	4,409	4,409	4,409	4,409	4,409	4,409	4,409	4,409	4,409	4,409	4,409	4,409	4,321	3,825	3,549	3,197	3,086	
SM	4,409	4,409	4,409	4,409	4,409	4,409	4,409	4,409	4,409	4,409	4,409	4,277	4,158	4,079	3,594	3,318	2,965	2,866	
DM	8,818	8,818	8,311	7,683	7,132	6,658	6,239	5,864	5,225	4,707	4,409	4,277	4,158	4,079	3,594	3,318	2,965	2,866	

Maximum Hook Heights at Jib Tip: H = 75'-2"
Maximum Hook Heights at Jib Foot: H = 68'-3"



Jib Configuration: L40 with maximum hook reach of 97'-1" at 0°

Hook Reach (ft)	9'-10"	45'-7"	49'-3"	52'-6"	55'-9"	59'-1"	62'-4"	65'-7"	72'-2"	81'-0"	82'-0"	84'-8"	85'-4"	88'-7"	97'-1"
Reeving	Capacities (lbs)														
SM1	4,409	4,409	4,409	4,409	4,409	4,409	4,409	4,409	4,409	4,409	4,409	4,409	4,370	4,178	3,748
SM	4,409	4,409	4,409	4,409	4,409	4,409	4,409	4,409	4,409	4,409	4,332	4,173	4,134	3,946	3,527
DM	8,818	8,818	8,058	7,441	6,911	6,449	6,041	5,677	5,060	4,409	4,332	4,173	4,134	3,946	3,527

Maximum Hook Heights at Jib Tip: H = 73'-6"
Maximum Hook Heights at Jib Foot: H = 68'-3"



Jib Configuration: L36 with maximum hook reach of 97'-1" at 0°

Hook Reach (ft)	9'-10"	45'-7"	49'-3"	52'-6"	55'-9"	59'-1"	62'-4"	65'-7"	72'-2"	81'-0"	82'-0"	84'-8"	85'-4"	88'-7"	97'-1"
Reeving	Capacities (lbs)														
SM1	4,409	4,409	4,409	4,409	4,409	4,409	4,409	4,409	4,409	4,409	4,409	4,409	4,370	4,178	3,748
SM	4,409	4,409	4,409	4,409	4,409	4,409	4,409	4,409	4,409	4,409	4,332	4,173	4,134	3,946	3,527
DM	8,818	8,818	8,058	7,441	6,911	6,449	6,041	5,677	5,060	4,409	4,332	4,173	4,134	3,946	3,527

Maximum Hook Heights at Jib Tip: H = 73'-6"
Maximum Hook Heights at Jib Foot: H = 68'-3"

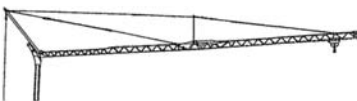

Jib Configuration: L28 with maximum hook reach of 91'-10" at 0°

Hook Reach (ft)	9'-10"	51'-6"	55'-9"	59'-1"	62'-4"	65'-7"	72'-2"	75'-6"	82'-0"	85'-4"	88'-7"	91'-10"
Reeving	Capacities (lbs)											
SM1	4,409	4,409	4,409	4,409	4,409	4,409	4,409	4,409	4,409	4,409	4,409	4,409
SM	4,409	4,409	4,409	4,409	4,409	4,409	4,409	4,409	4,409	4,409	4,409	4,409
DM	8,818	8,818	8,014	7,485	7,011	6,592	5,886	5,578	5,049	4,828	4,608	4,409

Maximum Hook Heights at Jib Tip: H = 73'-2"
Maximum Hook Heights at Jib Foot: H = 68'-3"

Igo 50

THIS CHART IS ONLY A GUIDE AND SHOULD NOT BE USED TO OPERATE THE CRANE. The individual crane's load chart, operating instructions and other instructional plates must be read and understood prior to operating the crane.

load charts

9

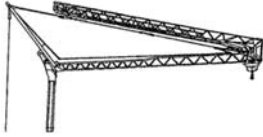

Jib Configuration: L36 with maximum hook reach of 45'-11" at 0°

Hook Reach (ft)	9'-10"	45'-11"	Capacities (lbs)									
Reeving												
SM1	4,409	4,409										
SM	4,409	4,409										
DM	8,818	8,818										

Maximum Hook Heights at Jib Tip: H = 69'-11"
Maximum Hook Heights at Jib Foot: H = 68'-3"



Jib Configuration: L36 with maximum hook reach of 45'-11" at 0°

Hook Reach (ft)	9'-10"	45'-11"	Capacities (lbs)									
Reeving												
SM1	4,409	4,409										
SM	4,409	4,409										
DM	8,818	8,818										

Maximum Hook Heights at Jib Tip: H = 69'-11"
Maximum Hook Heights at Jib Foot: H = 68'-3"

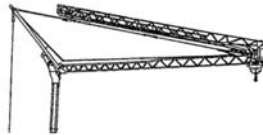

Jib Configuration: L28 with maximum hook reach of 45'-11" at 0°

Hook Reach (ft)	9'-10"	45'-11"	Capacities (lbs)									
Reeving												
SM1	4,409	4,409										
SM	4,409	4,409										
DM	8,818	8,818										

Maximum Hook Heights at Jib Tip: H = 69'-11"
Maximum Hook Heights at Jib Foot: H = 68'-3"

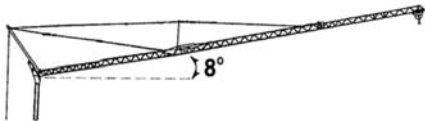

Jib Configuration: L40 with maximum hook reach of 129'-11" at 8°

Hook Reach (ft)	9'-10"	74'-6"	78'-5"	82'-0"	88'-7"	98'-5"	105'-0"	114'-10"	121'-5"	129'-11"
Reeving										
SM1	4,409	4,409	4,409	4,189	3,825	3,373	3,131	2,811	2,635	2,425
SM	4,409	4,409	4,156	3,924	3,571	3,131	2,888	2,579	2,403	2,205
DM										

Maximum Hook Heights at Jib Tip: H = 85'-11"
Maximum Hook Heights at Jib Foot: H = 68'-3"

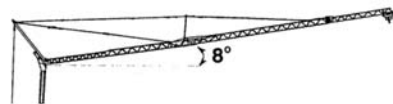

Jib Configuration: L36 with maximum hook reach of 116'-10" at 8°

Hook Reach (ft)	9'-10"	82'-4"	86'-3"	88'-7"	98'-5"	105'-0"	114'-10"	116'-10"
Reeving								
SM1	4,409	4,409	4,409	4,266	3,770	3,494	3,153	3,086
SM	4,409	4,409	4,165	4,023	3,549	3,274	2,932	2,866
DM								

Maximum Hook Heights at Jib Tip: H = 83'-4"
Maximum Hook Heights at Jib Foot: H = 68'-3"

THIS CHART IS ONLY A GUIDE AND SHOULD NOT BE USED TO OPERATE THE CRANE. The individual crane's load chart, operating instructions and other instructional plates must be read and understood prior to operating the crane.

Igo 50

load charts

10



Jib Configuration: L40 with maximum hook reach of 96'-2" at 8°

Hook Reach (ft)	9'-10"	80'-1"	83'-8"	88'-7"	96'-2"	Capacities (lbs)				
Reeving										
SM1	4,409	4,409	4,409	4,123	3,748					
SM	4,409	4,409	4,193	3,902	3,527					
DM										

Maximum Hook Heights at Jib Tip: H = 80'-1"
Maximum Hook Heights at Jib Foot: H = 68'-3"

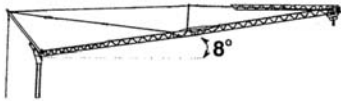

Jib Configuration: L36 with maximum hook reach of 96'-2" at 8°

Hook Reach (ft)	9'-10"	80'-1"	83'-8"	88'-7"	96'-2"	Capacities (lbs)				
Reeving										
SM1	4,409	4,409	4,409	4,123	3,748					
SM	4,409	4,409	4,193	3,902	3,527					
DM										

Maximum Hook Heights at Jib Tip: H = 80'-1"
Maximum Hook Heights at Jib Foot: H = 68'-3"

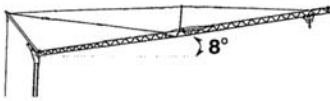

Jib Configuration: L28 with maximum hook reach of 90'-11" at 8°

Hook Reach (ft)	9'-10"	90'-11"	Capacities (lbs)							
Reeving										
SM1	4,409	4,409								
SM	4,409	4,409								
DM										

Maximum Hook Heights at Jib Tip: H = 79'-5"
Maximum Hook Heights at Jib Foot: H = 68'-3"

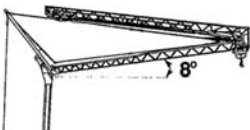

Jib Configuration: L40 with maximum hook reach of 45'-7" at 8°

Hook Reach (ft)	9'-10"	45'-7"	Capacities (lbs)							
Reeving										
SM1	4,409	4,409								
SM	4,409	4,409								
DM										

Maximum Hook Heights at Jib Tip: H = 72'-2"
Maximum Hook Heights at Jib Foot: H = 68'-3"

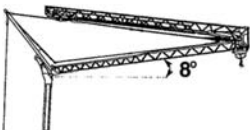

Jib Configuration: L36 with maximum hook reach of 45'-7" at 8°

Hook Reach (ft)	9'-10"	45'-7"	Capacities (lbs)							
Reeving										
SM1	4,409	4,409								
SM	4,409	4,409								
DM										

Maximum Hook Heights at Jib Tip: H = 72'-2"
Maximum Hook Heights at Jib Foot: H = 68'-3"

Igo 50

THIS CHART IS ONLY A GUIDE AND SHOULD NOT BE USED TO OPERATE THE CRANE. The individual crane's load chart, operating instructions and other instructional plates must be read and understood prior to operating the crane.

load charts

11

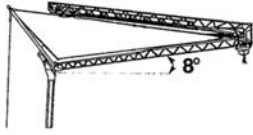

Jib Configuration: L28 with maximum hook reach of 45'-7" at 8°

Hook Reach (ft)	9'-10"	45'-7"	Capacities (lbs)							
Reeving										
SM1	4,409	4,409								
SM	4,409	4,409								
DM										

Maximum Hook Heights at Jib Tip: H = 72'-2"
 Maximum Hook Heights at Jib Foot: H = 68'-3"

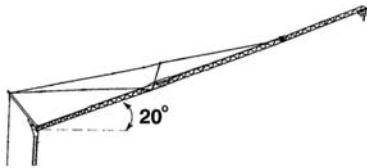

Jib Configuration: L40 with maximum hook reach of 123'-4" at 20°

Hook Reach (ft)	9'-10"	123'-4"	Capacities (lbs)							
Reeving										
SM1	2,425	2,425								
SM	2,205	2,205								
DM										

Maximum Hook Heights at Jib Tip: H = 110'-11"
 Maximum Hook Heights at Jib Foot: H = 68'-3"

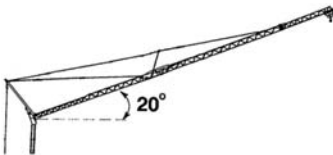

Jib Configuration: L36 with maximum hook reach of 111'-3" at 20°

Hook Reach (ft)	9'-10"	111'-3"	Capacities (lbs)							
Reeving										
SM1	2,425	2,425								
SM	2,205	2,205								
DM										

Maximum Hook Heights at Jib Tip: H = 105'-8"
 Maximum Hook Heights at Jib Foot: H = 68'-3"

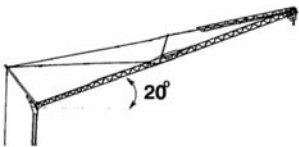

Jib Configuration: L40 with maximum hook reach of 91'-6" at 20°

Hook Reach (ft)	9'-10"	91'-6"	Capacities (lbs)							
Reeving										
SM1	2,425	2,425								
SM	2,205	2,205								
DM										

Maximum Hook Heights at Jib Tip: H = 97'-9"
 Maximum Hook Heights at Jib Foot: H = 68'-3"

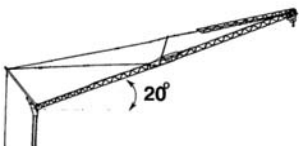

Jib Configuration: L36 with maximum hook reach of 91'-6" at 20°

Hook Reach (ft)	9'-10"	91'-6"	Capacities (lbs)							
Reeving										
SM1	2,425	2,425								
SM	2,205	2,205								
DM										

Maximum Hook Heights at Jib Tip: H = 97'-9"
 Maximum Hook Heights at Jib Foot: H = 68'-3"

THIS CHART IS ONLY A GUIDE AND SHOULD NOT BE USED TO OPERATE THE CRANE. The individual crane's load chart, operating instructions and other instructional plates must be read and understood prior to operating the crane.

Igo 50

load charts

12

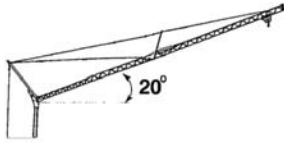

Jib Configuration: L28 with maximum hook reach of 86'-7" at 20°										
Hook Reach (ft)	9'-10"	86'-7"	Capacities (lbs)							
Reeving										
SM1	2,425	2,425								
SM	2,205	2,205								
DM										

Maximum Hook Heights at Jib Tip: H = 97'-1"
Maximum Hook Heights at Jib Foot: H = 68'-3"



Jib Configuration: L40 with maximum hook reach of 44'-0" at 20°										
Hook Reach (ft)	9'-10"	44'-0"	Capacities (lbs)							
Reeving										
SM1	2,425	2,425								
SM	2,205	2,205								
DM										

Maximum Hook Heights at Jib Tip: H = 80'-5"
Maximum Hook Heights at Jib Foot: H = 68'-3"

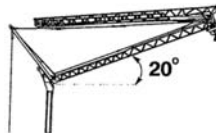

Jib Configuration: L36 with maximum hook reach of 44'-0" at 20°										
Hook Reach (ft)	9'-10"	44'-0"	Capacities (lbs)							
Reeving										
SM1	2,425	2,425								
SM	2,205	2,205								
DM										

Maximum Hook Heights at Jib Tip: H = 80'-5"
Maximum Hook Heights at Jib Foot: H = 68'-3"

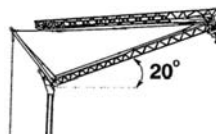

Jib Configuration: L28 with maximum hook reach of 44'-0" at 20°										
Hook Reach (ft)	9'-10"	44'-0"	Capacities (lbs)							
Reeving										
SM1	2,425	2,425								
SM	2,205	2,205								
DM										

Maximum Hook Heights at Jib Tip: H = 80'-5"
Maximum Hook Heights at Jib Foot: H = 68'-3"

Reeving Abreviations

- SM1 = 2-part line configuration with section of hookblock removed
- SM = 2-part line configuration with section of hookblock stowed at jib
- DM = 4-part line configuration

Jib Configurations

- L40 (131 ft / 40 m) = standard jib with jib extension (13 ft / 4 m)
- L36 (118 ft / 36 m) = standard jib
- L28 (92 ft / 28 m) = standard jib with nose removed

Igo 50

THIS CHART IS ONLY A GUIDE AND SHOULD NOT BE USED TO OPERATE THE CRANE. The individual crane's load chart, operating instructions and other instructional plates must be read and understood prior to operating the crane.

metric dimensions

13

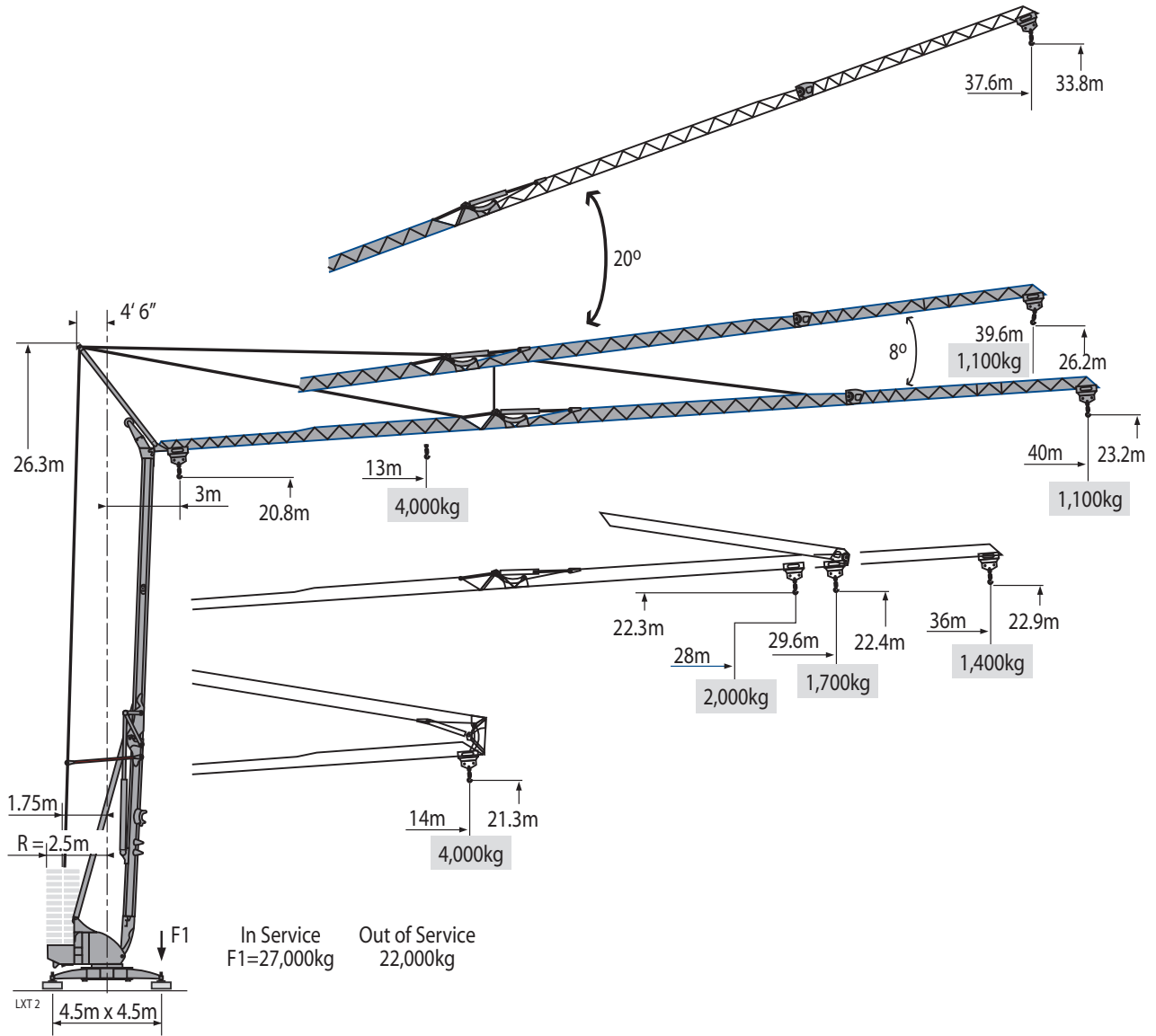

Unit Weight: 14,875 kg

THIS CHART IS ONLY A GUIDE AND SHOULD NOT BE USED TO OPERATE THE CRANE. The individual crane's load chart, operating instructions and other instructional plates must be read and understood prior to operating the crane.

Igo 50

metric crane profile

14

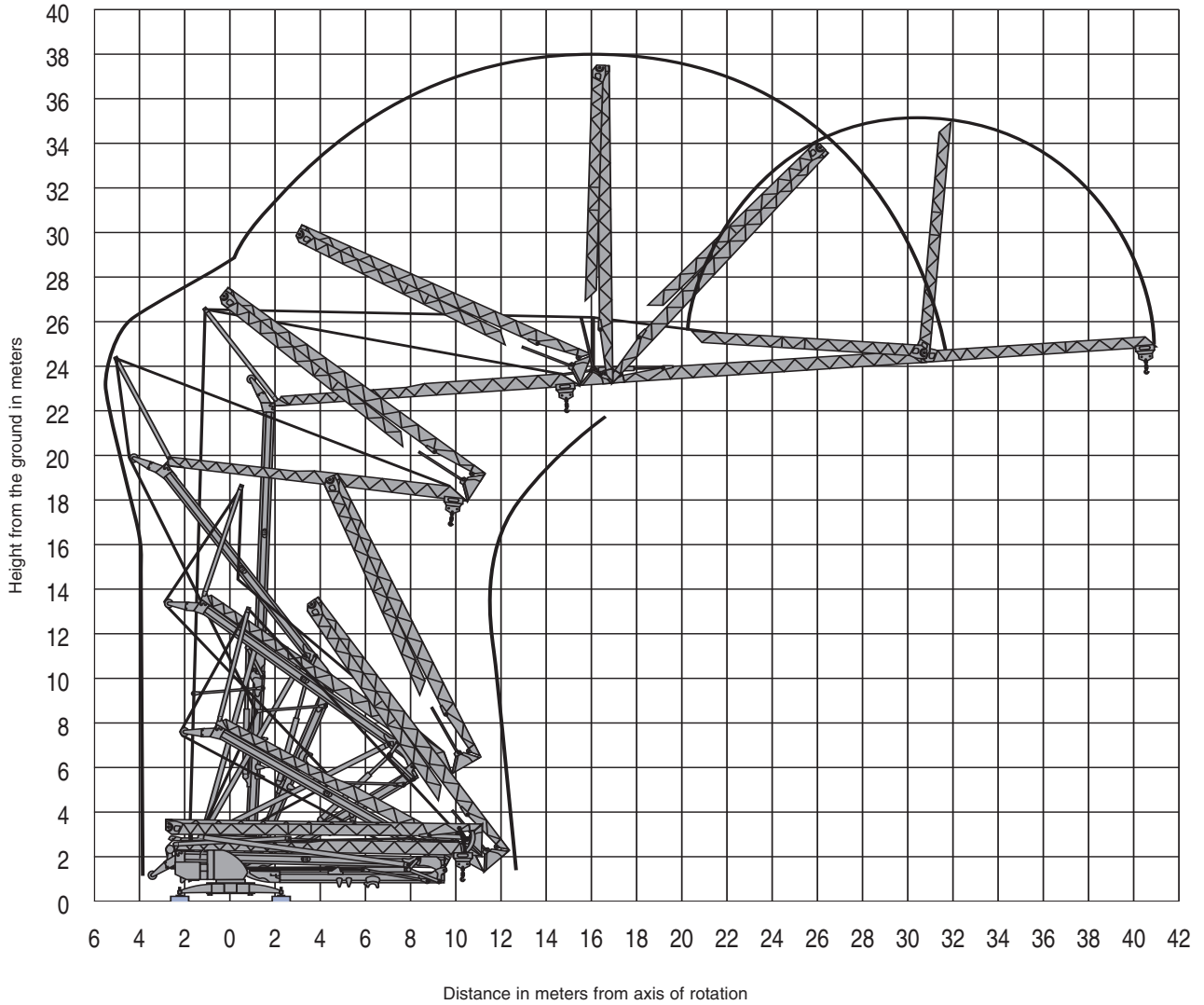

Igo 50

THIS CHART IS ONLY A GUIDE AND SHOULD NOT BE USED TO OPERATE THE CRANE. The individual crane's load chart, operating instructions and other instructional plates must be read and understood prior to operating the crane.

metric load charts

15



Jib Configuration: L40 with maximum hook reach of 40 m at 0°

Hook Reach (m)	3	13	14	15	16	17	18	19	20	23	24	24.2	25	27	30	32	35	37	40
Reeving	Capacities (kg)																		
SM1	2,000	2,000	2,000	2,000	2,000	2,000	2,000	2,000	2,000	2,000	2,000	2,000	1,920	1,755	1,550	1,435	1,290	1,210	1,100
SM	2,000	2,000	2,000	2,000	2,000	2,000	2,000	2,000	2,000	2,000	1,895	1,876	1,800	1,640	1,440	1,330	1,185	1,105	1,000
DM	4,000	4,000	3,665	3,365	3,105	2,885	2,690	2,520	2,365	2,000	1,895	1,876	1,800	1,640	1,440	1,330	1,185	1,105	1,000

Maximum Hook Heights at Jib Tip: H = 23.2m

Maximum Hook Heights at Jib Foot: H = 20.8m



Jib Configuration: L36 with maximum hook reach of 36m at 0°

Hook Reach (m)	3	14.3	15	16	17	18	19	20	22	24.2	25.3	26	26	27	30	32	35	36	
Reeving	Capacities (kg)																		
SM1	2,000	2,000	2,000	2,000	2,000	2,000	2,000	2,000	2,000	2,000	2,000	2,000	2,000	1,960	1,735	1,610	1,450	1,400	
SM	2,000	2,000	2,000	2,000	2,000	2,000	2,000	2,000	2,000	2,000	2,000	1,940	1,886	1,850	1,630	1,505	1,345	1,300	
DM	4,000	4,000	3,770	3,485	3,235	3,020	2,830	2,660	2,370	2,135	2,000	1,940	1,886	1,850	1,630	1,505	1,345	1,300	

Maximum Hook Heights at Jib Tip: H = 22.9m

Maximum Hook Heights at Jib Foot: H = 20.8m



Jib Configuration: L40 with maximum hook reach of 29.6m at 0°

Hook Reach (m)	3	13.9	15	16	17	18	19	20	22	24.7	25	25.8	26	27	29.6	
Reeving	Capacities (kg)															
SM1	2,000	2,000	2,000	2,000	2,000	2,000	2,000	2,000	2,000	2,000	2,000	2,000	1,982	1,895	1,700	
SM	2,000	2,000	2,000	2,000	2,000	2,000	2,000	2,000	2,000	2,000	2,000	1,965	1,893	1,875	1,600	
DM	4,000	4,000	3,655	3,375	3,135	2,925	2,740	2,575	2,295	2,000	1,965	1,893	1,875	1,790	1,600	

Maximum Hook Heights at Jib Tip: H = 22.4m

Maximum Hook Heights at Jib Foot: H = 20.8m



Jib Configuration: L36 with maximum hook reach of 29.6m at 0°

Hook Reach (m)	3	13.9	15	16	17	18	19	20	22	24.7	25	25.8	26	27	29.6	
Reeving	Capacities (kg)															
SM1	2,000	2,000	2,000	2,000	2,000	2,000	2,000	2,000	2,000	2,000	2,000	2,000	1,982	1,895	1,700	
SM	2,000	2,000	2,000	2,000	2,000	2,000	2,000	2,000	2,000	2,000	2,000	1,965	1,893	1,875	1,600	
DM	4,000	4,000	3,655	3,375	3,135	2,925	2,740	2,575	2,295	2,000	1,965	1,893	1,875	1,790	1,600	

Maximum Hook Heights at Jib Tip: H = 22.4m

Maximum Hook Heights at Jib Foot: H = 20.8m



Jib Configuration: L28 with maximum hook reach of 28m at 0°

Hook Reach (m)	3	15.7	17	18	19	20	22	23	25	26	27	28	
Reeving	Capacities (kg)												
SM1	2,000	2,000	2,000	2,000	2,000	2,000	2,000	2,000	2,000	2,000	2,000	2,000	
SM	2,000	2,000	2,000	2,000	2,000	2,000	2,000	2,000	2,000	2,000	2,000	2,000	
DM	4,000	4,000	3,635	3,395	3,180	2,990	2,670	2,530	2,290	2,190	2,090	2,000	

Maximum Hook Heights at Jib Tip: H = 22.3m

Maximum Hook Heights at Jib Foot: H = 20.8m

THIS CHART IS ONLY A GUIDE AND SHOULD NOT BE USED TO OPERATE THE CRANE. The individual crane's load chart, operating instructions and other instructional plates must be read and understood prior to operating the crane.

metric load charts

16



Jib Configuration: L40 with maximum hook reach of 14m at 0°

Hook Reach (m)	3		14		Capacities (kg)						
Reeving											
SM1	2,000	2,000									
SM	2,000	2,000									
DM	4,000	4,000									

Maximum Hook Heights at Jib Tip: H = 21.3m
Maximum Hook Heights at Jib Foot: H = 20.8m



Jib Configuration: L36 with maximum hook reach of 14m at 0°

Hook Reach (m)	3		14		Capacities (kg)						
Reeving											
SM1	2,000	2,000									
SM	2,000	2,000									
DM	4,000	4,000									

Maximum Hook Heights at Jib Tip: H = 21.3m
Maximum Hook Heights at Jib Foot: H = 20.8m



Jib Configuration: L28 with maximum hook reach of 14m at 0°

Hook Reach (m)	3		14		Capacities (kg)						
Reeving											
SM1	2,000	2,000									
SM	2,000	2,000									
DM	4,000	4,000									

Maximum Hook Heights at Jib Tip: H = 21.3m
Maximum Hook Heights at Jib Foot: H = 20.8m

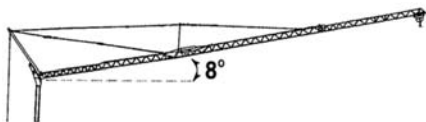

Jib Configuration: L40 with maximum hook reach of 40m at 8°

Hook Reach (m)	3	22.7	23.9	25	27	30	32	35	37	39.6
Reeving	Capacities (kg)									
SM1	2,000	2,000	2,000	1,900	1,735	1,530	1,420	1,275	1,195	1,100
SM	2,000	2,000	1,885	1,780	1,620	1,420	1,310	1,170	1,090	1,000
DM										

Maximum Hook Heights at Jib Tip: H = 26.2m
Maximum Hook Heights at Jib Foot: H = 20.8m



Jib Configuration: L36 with maximum hook reach of 36m at 8°

Hook Reach (m)	3	25.1	26.3	27	30	32	35	35.6
Reeving	Capacities (kg)							
SM1	2,000	2,000	2,000	1,935	1,710	1,585	1,430	1,400
SM	2,000	2,000	1,889	1,825	1,610	1,485	1,330	1,300
DM								

Maximum Hook Heights at Jib Tip: H = 25.4m
Maximum Hook Heights at Jib Foot: H = 20.8m

Igo 50

THIS CHART IS ONLY A GUIDE AND SHOULD NOT BE USED TO OPERATE THE CRANE. The individual crane's load chart, operating instructions and other instructional plates must be read and understood prior to operating the crane.

metric load charts



Jib Configuration: L40 with maximum hook reach of 29.3m at 8°

Hook Reach (m)	3	24.4	25.5	27	29.3	Capacities (kg)				
Reeving										
SM1	2,000	2,000	2,000	1,870	1,700					
SM	2,000	2,000	1,902	1,770	1,600					
DM										

Maximum Hook Heights at Jib Tip: H = 24.4m
Maximum Hook Heights at Jib Foot: H = 20.8m

17



Jib Configuration: L36 with maximum hook reach of 29.3m at 8°

Hook Reach (m)	3	24.4	25.5	27	29.3	Capacities (kg)				
Reeving										
SM1	2,000	2,000	2,000	1,870	1,700					
SM	2,000	2,000	1,902	1,770	1,600					
DM										

Maximum Hook Heights at Jib Tip: H = 24.4m
Maximum Hook Heights at Jib Foot: H = 20.8m

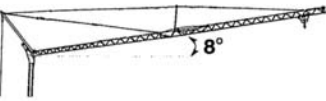

Jib Configuration: L28 with maximum hook reach of 27.7m at 8°

Hook Reach (m)	3	27.7	Capacities (kg)							
Reeving										
SM1	2,000	2,000								
SM	2,000	2,000								
DM										

Maximum Hook Heights at Jib Tip: H = 24.2m
Maximum Hook Heights at Jib Foot: H = 20.8m

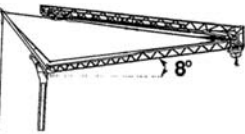

Jib Configuration: L40 with maximum hook reach of 13.9m at 8°

Hook Reach (m)	3	13.9	Capacities (kg)							
Reeving										
SM1	2,000	2,000								
SM	2,000	2,000								
DM										

Maximum Hook Heights at Jib Tip: H = 22m
Maximum Hook Heights at Jib Foot: H = 20.8m

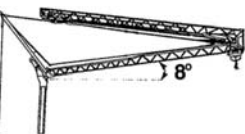

Jib Configuration: L36 with maximum hook reach of 13.9m at 8°

Hook Reach (m)	3	13.9	Capacities (kg)							
Reeving										
SM1	2,000	2,000								
SM	2,000	2,000								
DM										

Maximum Hook Heights at Jib Tip: H = 22m
Maximum Hook Heights at Jib Foot: H = 20.8m

Igo 50

THIS CHART IS ONLY A GUIDE AND SHOULD NOT BE USED TO OPERATE THE CRANE. The individual crane's load chart, operating instructions and other instructional plates must be read and understood prior to operating the crane.

metric load charts

18

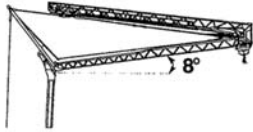

Jib Configuration: L28 with maximum hook reach of 13.9m at 8°

Hook Reach (m)	3	13.9	Capacities (kg)							
Reeving										
SM1	2,000	2,000								
SM	2,000	2,000								
DM										

Maximum Hook Heights at Jib Tip: H = 22m
Maximum Hook Heights at Jib Foot: H = 20.8m

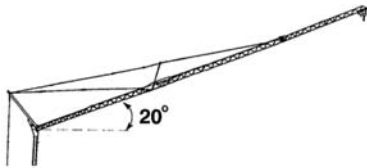

Jib Configuration: L40 with maximum hook reach of 37.6m at 20°

Hook Reach (m)	3	37.6	Capacities (kg)							
Reeving										
SM1	1,100	1,100								
SM	1,000	1,000								
DM										

Maximum Hook Heights at Jib Tip: H = 33.8m
Maximum Hook Heights at Jib Foot: H = 20.8m

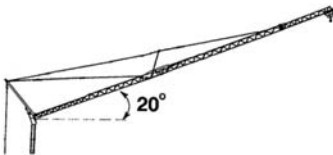

Jib Configuration: L36 with maximum hook reach of 33.9m at 20°

Hook Reach (m)	3	33.9	Capacities (kg)							
Reeving										
SM1	1,100	1,100								
SM	1,000	1,000								
DM										

Maximum Hook Heights at Jib Tip: H = 32.2m
Maximum Hook Heights at Jib Foot: H = 20.8m

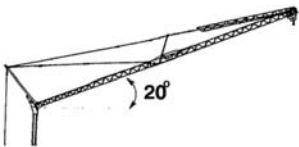

Jib Configuration: L40 with maximum hook reach of 27.9m at 20°

Hook Reach (m)	3	27.9	Capacities (kg)							
Reeving										
SM1	1,100	1,100								
SM	1,000	1,000								
DM										

Maximum Hook Heights at Jib Tip: H = 29.8m
Maximum Hook Heights at Jib Foot: H = 20.8m

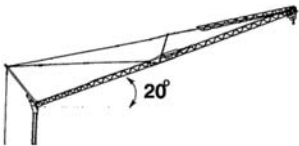

Jib Configuration: L36 with maximum hook reach of 27.9m at 20°

Hook Reach (m)	3	27.9	Capacities (kg)							
Reeving										
SM1	1,100	1,100								
SM	1,000	1,000								
DM										

Maximum Hook Heights at Jib Tip: H = 29.8m
Maximum Hook Heights at Jib Foot: H = 20.8m

Igo 50

THIS CHART IS ONLY A GUIDE AND SHOULD NOT BE USED TO OPERATE THE CRANE. The individual crane's load chart, operating instructions and other instructional plates must be read and understood prior to operating the crane.

metric load charts

19

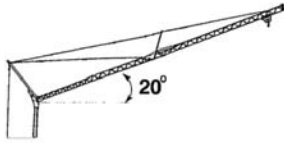

Jib Configuration: L28 with maximum hook reach of 26.4m at 20°

Hook Reach (m)	3	26.4	Capacities (kg)							
Reeving										
SM1	1,100	1,100								
SM	1,000	1,000								
DM										

Maximum Hook Heights at Jib Tip: H = 29.6m
Maximum Hook Heights at Jib Foot: H = 20.8m

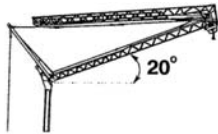

Jib Configuration: L40 with maximum hook reach of 13.4m at 20°

Hook Reach (m)	3	13.4	Capacities (kg)							
Reeving										
SM1	1,100	1,100								
SM	1,000	1,000								
DM										

Maximum Hook Heights at Jib Tip: H = 24.5m
Maximum Hook Heights at Jib Foot: H = 20.8m

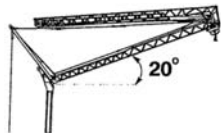

Jib Configuration: L36 with maximum hook reach of 13.4m at 20°

Hook Reach (m)	3	13.4	Capacities (kg)							
Reeving										
SM1	1,100	1,100								
SM	1,000	1,000								
DM										

Maximum Hook Heights at Jib Tip: H = 24.5m
Maximum Hook Heights at Jib Foot: H = 20.8m

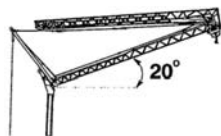

Jib Configuration: L28 with maximum hook reach of 13.4m at 20°

Hook Reach (m)	3	13.4	Capacities (kg)							
Reeving										
SM1	1,100	1,100								
SM	1,000	1,000								
DM										

Maximum Hook Heights at Jib Tip: H = 24.5m
Maximum Hook Heights at Jib Foot: H = 20.8m

Reeving Abbreviations

- SM1 = 2-part line configuration with section of hookblock removed
- SM = 2-part line configuration with section of hookblock stowed at jib
- DM = 4-part line configuration

Jib Configurations



- L40 (131 ft / 40 m) = standard jib with jib extension (13 ft / 4 m)
- L36 (118 ft / 36 m) = standard jib
- L28 (92 ft / 28 m) = standard jib with nose removed

THIS CHART IS ONLY A GUIDE AND SHOULD NOT BE USED TO OPERATE THE CRANE. The individual crane's load chart, operating instructions and other instructional plates must be read and understood prior to operating the crane.

Igo 50

mechanical data

20

		CEI 38					IEC 38					HP	kW	
	15 LVF 10 Optima	ft/min	12	59	98	161	217						15	11
		(m/min)	(3.6)	(18)	(30)	(49)	(66)							
		lb	4,409	4,409	4,409	2,425	1,102							
		(kg)	(2,000)	(2,000)	(2,000)	(1,100)	(500)							
		ft/min	12	59	98	177	217	6	29	49	89	108		
		(m/min)	(3.6)	(18)	(30)	(54)	(66)	(1.8)	(8.9)	(15)	(27)	(33)		
lb	4,409	4,409	4,409	2,204	1,102	8,818	8,818	8,818	4,409	2,204				
(kg)	(2,000)	(2,000)	(2,000)	(1,000)	(500)	(4,000)	(4,000)	(4,000)	(2,000)	(1,000)				
	3 DVF 5	ft/min	62.3 - 147.6 (0 → 2,004 lb) - 62.3 - 134.5 (2,204 → 8,818.5 lb)										3	2.2
		(m/min)	19 - 45 (0 → 1,000 kg) - 19 - 41 (1,000 → 4,000 kg)											
	RVF+ 51	RPM	0 - 0.8										5.5	4

CEI 38	IEC 38	kVA
480 V (+6%-10%) 60 Hz		15 LVF 10 : 23 kVA

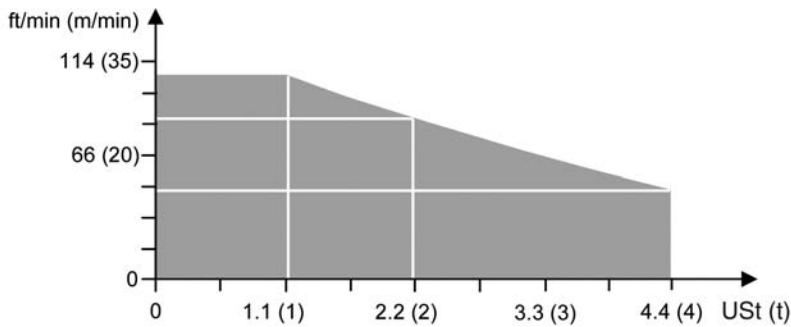

Warning Systems

Limit Moment Cut-Out – Prevents a moment that is more than +10%.

Warning

1. The operator must read and understand the owner's manual before operating this crane.
2. Positioning or operation of crane beyond areas shown is not intended or approved except where specified in owner's manual.
3. Practical working loads depend on supporting surface, wind, and other factors affecting stability such as hazardous surroundings, experience of personnel, and proper handling, all of which must be taken into account by the operator.

Igo 50

THIS CHART IS ONLY A GUIDE AND SHOULD NOT BE USED TO OPERATE THE CRANE. The individual crane's load chart, operating instructions and other instructional plates must be read and understood prior to operating the crane.

symbols glossary



Jib



Mast



Anemometer



Swing



Outrigger



Chassis



Hydraulic Equipment



Controls



Electrical Requirement



Ballast



Transport Axle



Ballasting Derrick



Reeving



Hoist



Trolley



Jib Extension

Regional Headquarters

Americas

Manitowoc, Wisconsin, USA

Tel: +1 920 684 6621

Fax: +1 920 683 6278

Shady Grove, Pennsylvania, USA

Tel: +1 717 597 8121

Fax: +1 717 597 4062

Regional Offices

Americas

Brazil

Alphaville

Tel: +55 11 3103 0200

Fax: +55 11 4688 2013

Mexico

Monterrey

Tel: +52 81 8124 0128

Fax: +52 81 8124 0129

Europe, Middle East, Africa

Algeria

Hydra

Tel: +21 3 21 48 1173

Fax: +21 3 21 48 1454

Czech Republic

Netvorice

Tel: +420 317 78 9313

Fax: +420 317 78 9314

France

Baudemont

Tel: +33 385 28 2589

Fax: +33 385 28 0430

Cergy

Tel: +33 130 31 3150

Fax: +33 130 38 6085

Decines

Tel: +33 472 81 5000

Fax: +33 472 81 5010

Germany

Langenfeld

Tel: +49 21 73 8909-0

Fax: +49 21 73 8909 30

Hungary

Budapest

Tel: +36 13 39 8622

Fax: +36 13 39 8622

Italy

Parabiago

Tel: +390 331 49 3311

Fax: +390 331 49 3330

Europe, Middle East, Africa

Ecully, France

Tel: +33 472 18 2020

Fax: +33 472 18 2000

Netherlands

Breda

Tel: +31 76 578 3999

Fax: +31 76 578 3978

Poland

Warsaw

Tel: +48 22 843 3824

Fax: +48 22 843 3471

Portugal

Alfena

Tel: +351 229 69 8840

Fax: +351 229 69 8848

Lisbon

Tel: +351 212 109 340

Fax: +351 212 109 349

Russia

Moscow

Tel: +7 495 641 2359

Fax: +7 495 641 2358

U.A.E.

Dubai

Tel: +971 4 3381 861

Fax: +971 4 3382 343

U. K.

Middlesex

Tel: +44 1 895 43 0053

Fax: +44 1 895 45 9500

Sunderland

Tel: +44 191 522 2000

Fax: +44 191 522 2052

Asia – Pacific

Australia

Brisbane

38 Suscatand Street
Rocklea Queensland 4106

Tel: +617 3274 5879

Fax: +617 3274 6558

Melbourne

1/46 Venture Drive
Sunshine West VIC 3020

Tel: +(03) 9336 1322

Fax: +(03) 9336 1300

Asia – Pacific

Shanghai, China

Tel: +86 21 51113579

Fax: +86 21 51113578

Singapore

Tel: +65 6264 1188

Fax: +65 6862 4142

China

Beijing

Tel: +86 10 58674761

Fax: +86 10 58674760

Xi'an

Tel: +86 29 87891465

Fax: +86 29 87884504

Korea

Seoul

Tel: +82 2 3439 0400

Fax: +82 2 3439 0405

Philippines

Makati City

Tel: +63 2 844 9437

Fax: +63 2 844 4712

Factories

Brazil

Alphaville

China

Zhangjiagang

France

Charlieu

La Clayette

Moulins

Germany

Wilhelmshaven

India

Calcutta

Pune

Italy

Niella Tanaro

Portugal

Baltar

Fânzeres

Slovakia

Saris

U.S.A.

Manitowoc

Port Washington

Shady Grove

Constant improvement and engineering progress make it necessary that we reserve the right to make specification, equipment and price changes without notice. Illustrations shown may include optional equipment and accessories, and may not include all standard equipment.